

AIGUILLES À PERFORER

PERFORATING NEEDLES

ГОЛКИ ДЛЯ ПЕРФОРАЦІЇ

ИГОЛКИ ДЛЯ ПЕРФОРАЦИИ

AGUJAS DE PERFORAR

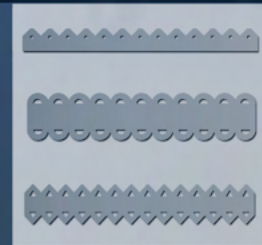
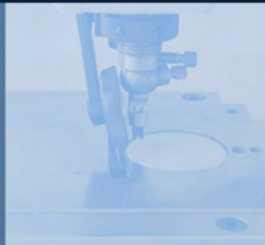

Nuestras "Agujas de Perforar" están fabricadas con aceros de alta calidad y verificado cada proceso de fabricación. Todo ello unido a nuestra larga experiencia "desde 1934" nos permiten garantizar su rendimiento. Esperamos encuentren el modelo que necesitan, de no ser así, traten de elegir el más parecido posible, si no lo encuentran podemos fabricarlo especialmente para ustedes. Si están interesados en alguna máquina soliciten catálogo detallado. Nos reservamos el derecho de cualquier modificación.

Our "Perforating Needles" are manufactured with high quality steel and each process of their manufacture is tested. All this, together with our great experience "since 1934" allows us to guarantee their performance. We hope you find the models you need, otherwise, try to find the most suitable substitute. As a last resort if you can't find the required model we can manufacture it especially for you. If you are interested on any machine, ask us for a detailed brochure. We reserve the right to whatever modification.

Nos "Aiguilles à Perforer" sont fabriquées en acier de haute qualité, et chaque procés de leur fabrication est verifié. Tout celà, uni à notre grande expérience "depuis 1934" nous permet de garantir leur efficacité. Nous espérons que vous rencontrerez les modeles dont vous avez besoin d'autre main vous pouvez trouvez une substituée qui vous satisfait. Dans le cas extrême de ne trouver pas le modele désiré, nous pouvons vous le fabriquer. Si vous êtes intéressé à nos machines, demandez notre brochure détaillée. Nous nous reservons le droit de toute modification.

GILMA[®]
TECHNOLOGY SA



Mod. **G-100**



MAQUINA DE PERFORAR PIEL Y SIMILARES
LEATHER AND SIMILAR PUNCHING MACHINE
MACHINE À PERFORER LE CUIR ET SIMILAIRES
МАШИНА ДЛЯ ПЕРФОРАЦІЇ ШКИРИ ТА ПОДІБНИХ МАТЕРІАЛІВ
МАШИНА ДЛЯ ПЕРФОРАЦИИ КОЖИ И ПОДОБНЫХ МАТЕРИАЛОВ

GILMA[®]
TECHNOLOGY SA

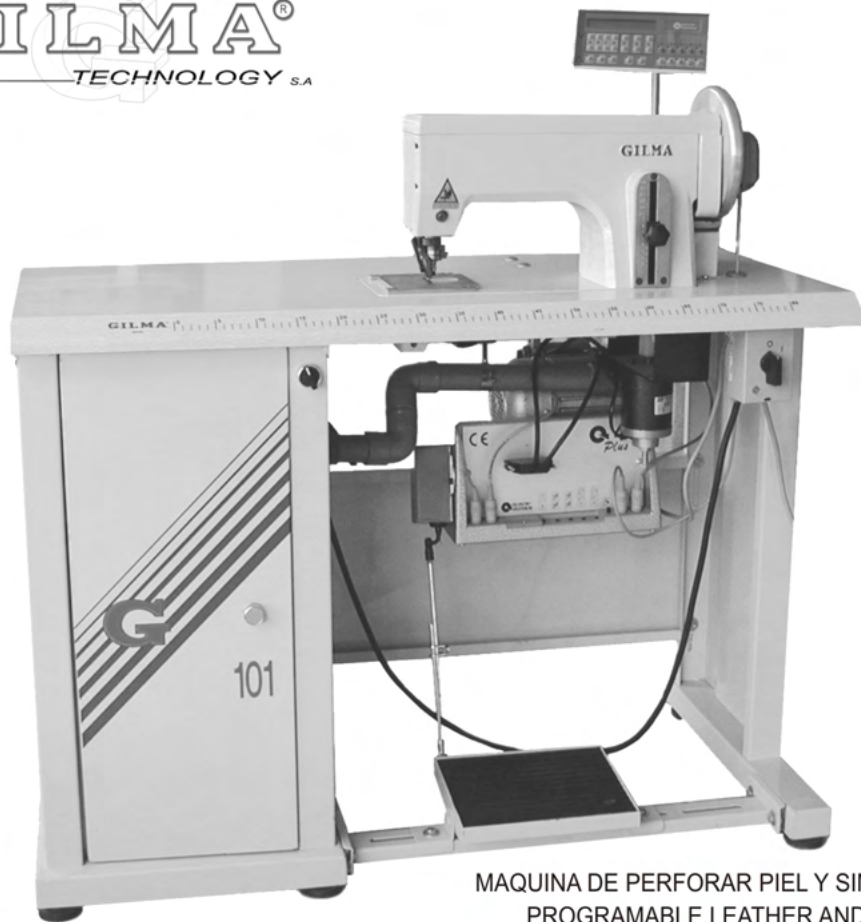

Mod. **G-101**



MAQUINA DE PERFORAR PIEL Y SIMILARES CON PROGRAMADOR
PROGRAMABLE LEATHER AND SIMILAR PUNCHING MACHINE
MACHINE À PERFORER LE CUIR ET SIMILAIRES AVEC PROGRAMMATEUR
ПРОГРАМОВАНА МАШИНА ДЛЯ ПЕРФОРАЦІЇ ШКИРИ ТА ПОДІБНИХ МАТЕРІАЛІВ
ПРОГРАММИРУЕМАЯ МАШИНА ДЛЯ ПЕРФОРАЦИИ КОЖИ И ПОДОБНЫХ МАТЕРИАЛОВ

MAQUINARIA

MACHINERY

MACHINES

МАШИНА



Mod. **G-400**



МАШИНА

MACHINES

MACHINERY

MAQUINARIA

MAQUINA DE PERFORAR AUTOMATICA POR AVANCE
AUTOMATIC PUNCHING MACHINE BY FEED
MACHINE À PERFORER AUTOMATIQUE PAR AVANCE
АВТОМАТИЧНА МАШИНА ДЛЯ ПОКРОКОВОЇ ПЕРФОРАЦІЇ
АВТОМАТИЧЕСКАЯ МАШИНА ДЛЯ ПОШАГОВОЙ ПЕРФОРАЦИИ



Mod. **G-400S**



MAQUINA DE PERFORAR AUTOMATICA POR AVANCE CON PROGRAMADOR
PROGRAMABLE AUTOMATIC PUNCHING MACHINE BY FEED
MACHINE À PERFORER AUTOMATIQUE PAR AVANCE AVEC PROGRAMMATEUR
АВТОМАТИЧНА ПРОГРАМОВАНА МАШИНА ДЛЯ ПОКРОКОВОЇ ПЕРФОРАЦІЇ
АВТОМАТИЧЕСКАЯ ПРОГРАММИРУЕМАЯ МАШИНА ДЛЯ ПОШАГОВОЙ ПЕРФОРАЦИИ

GILMA[®]
TECHNOLOGY S.A



Mod. **G-500**



MAQUINA DE RANURA PLANTAS
INSOLE SLOTING MACHINE
MACHINE À RAINURER LES PREMIERES
МАШИНА ДЛЯ НАНЕСЕННЯ РЕЛЬСФА НА ПІДОШВИ
МАШИНА ДЛЯ НАНЕСЕНИЯ РЕЛЬЕФА НА ПОДОШВЫ



MAQUINA DE HACER AGUJEROS A LAS CORREAS
BELT PUNCHING MACHINE
MACHINE À PERFORER LES COURROTES

ПНЕВМАТИЧНА МАШИНА ДЛЯ ПРОБИВАННЯ ОТВОРІВ У РЕМЕНЯХ
ПНЕВМАТИЧЕСКАЯ МАШИНА ДЛЯ ПРОДЕЛЫВАНИЯ ОТВЕРСТИЙ В РЕМНЯХ



Mod. **G-200**



MAQUINA DE PERFORAR A PEDAL Y PONER FORNITURAS
MACHINE FOR PERFORATING BY PEDAL AND PUTTING ADORNMENTS
MACHINE À PERFORER PAR PÉDALE ET POUR PLACER GARNITURES
МАШИНА ДЛЯ ПЕРФОРАЦІЇ ТА ЗАКРІПЛЕННЯ ФУРНІТУРИ (З ПЕДАЛЛЮ)
МАШИНА ДЛЯ ПЕРФОРАЦІЇ И ЗАКРЕПЛЕНІЯ ФУРНІТУРЫ (С ПЕДАЛЬЮ)

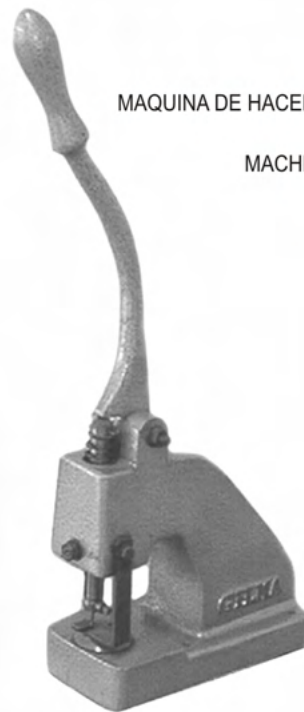
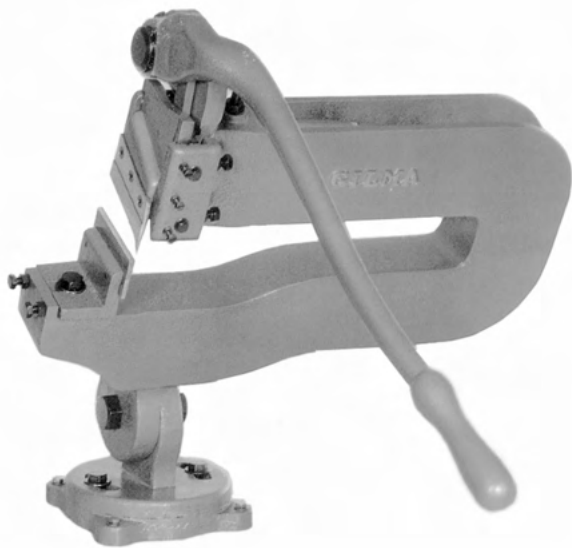

Mod. **G-PP**

MAQUINA DE HACER PINCHAZOS A LOS PATRONES A MANO
HAND PUNCHING PATTERNS MACHINE
MACHINE À PERFORER LES GABARITS À MAIN

Mod. **G-CP2**

CIZALLA PATRONISTA
PATTERNS CUTTING MACHINE
CISAILLES À COUPER LES GABARITS
НОЖИЦІ ДЛЯ ЛЕКАЛ
НОЖНИЦЫ ДЛЯ ЛЕКАЛ



*Punzones para
 escalar patrones
 Ø1.6 - 1.75 - 2 - 2.2 - 2.4 mm.*



Punzones guía



*Pinza Linhan - Albeko
 Ø3 - 3.2 mm.*



*Tornillo para la sujeción
 de originales
 Linhan - Albeko*



*Matriz Universal
 Ø1.6 - 1.75 - 2 - 2.2 - 2.4 mm.*



*Matriz Comelz
 Ø2 - 2.2 - 2.4 mm.*



*Matriz Felice - Lince - Albeko - Teseo - Elitron
 Ø1.6 - 1.75 - 2 - 2.2 - 2.4 mm.*

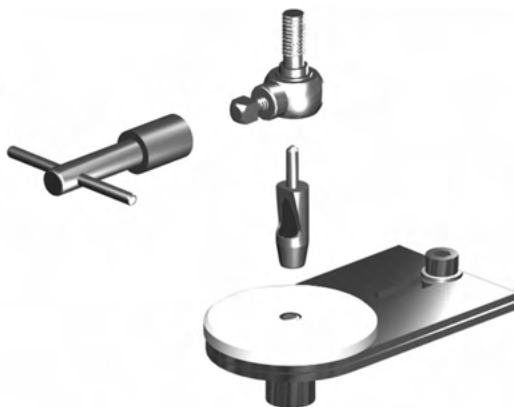

- Accesorios para perforar adaptables a las máquinas de poner fornituras (no automáticas).

- Punching accessories adaptable to non automatic rivet fitting machines.

- Accessoires pour perforer adaptables à les machines a placer fornitures (no automatiques).

- Mango universal para perforar a golpe.

- Adaptable handle hand punching.

- Poignée pour perforer à la main.

- Tenaza para perforar.

- Punching pliers.

- Tenailles à perforer.

ARTICULO

1)

ESPECIALES

000	00	0
0.5	0.6	0.7

Agujero - Trou - Hole Ø

1	2	3	4	5	6	7	8	9	10	11	12
0.6	0.7	0.8	1	1.25	1.5	1.75	2	2.25	2.5	2.75	3

13	14	15	16	17	18	19	20	21	22	23	24	25
Ø 3.5	4	4.5	5	5.5	6	6.5	7	7.5	8	8.5	9	9.5

26	27	28	29	30	30½	31	31½	32	33
Ø 10	10.5	11	12	13	14	15	16	17	19

ARTICULO

Fabricación en festón doble
Double gimped production
Production en double dentelé

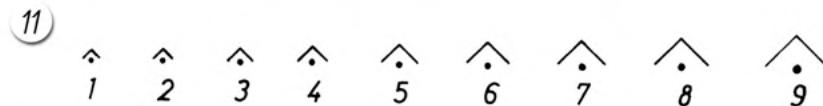
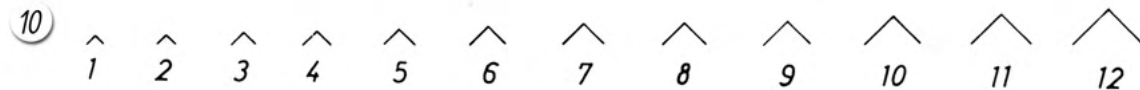
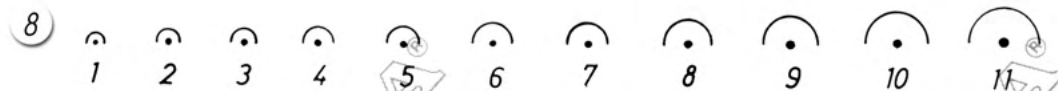
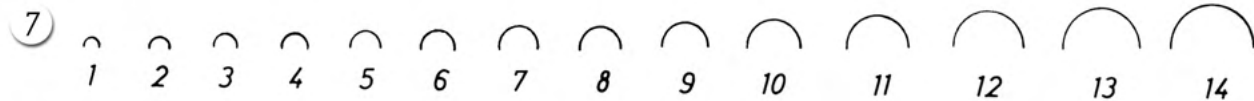

*medida de ancho bajo pedido
Wide measure under order
Mesure du large sur comande

- EJEMPLOS Art. 7 - 11A



ARTICULO

F-1a



F-1b



F-2a



F-2b



F-3a



F-3b



F-4



F-5

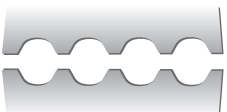

F-6



F-7



F-8



F-9



F-10



F-11



F-12a



F-12b



ARTICULO

12

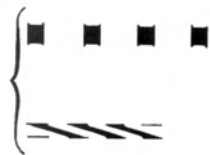
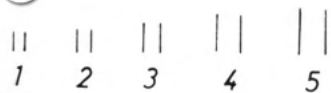

16

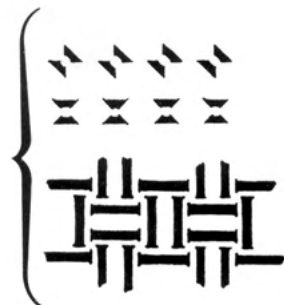

13

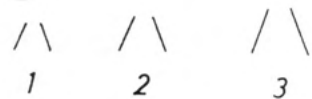

17

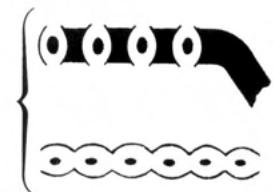
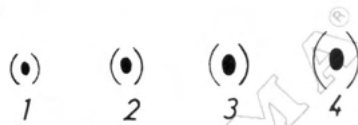

14

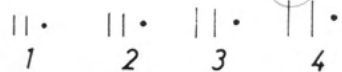

18



15

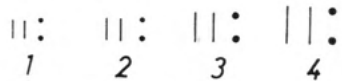

19

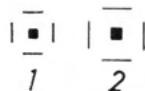

ARTICULO

20-A



20

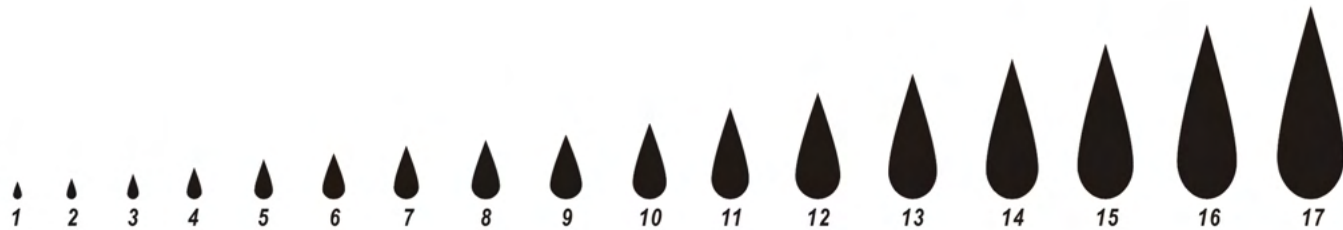

21



ARTICULO

22-A



22

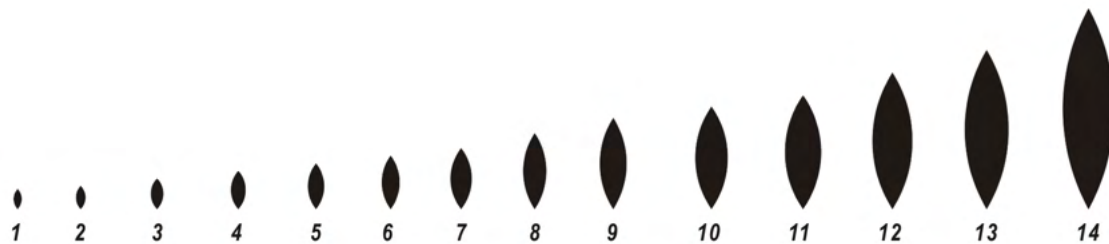

ARTICULO

23

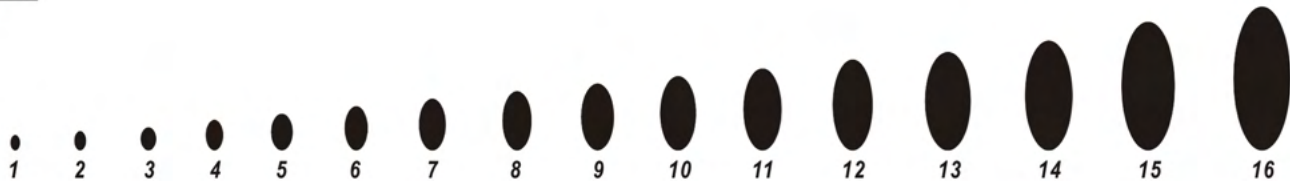

24



25



ARTICULO

26



27



28



29



ARTICULO

30



31



32



33



34



ARTICULO

35



36



37



38



ARTICULO

39

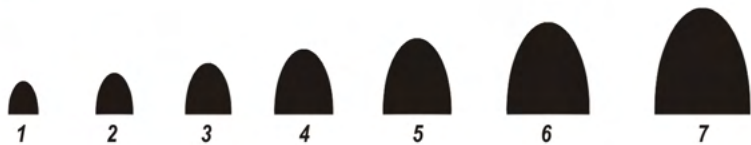

40



41



42

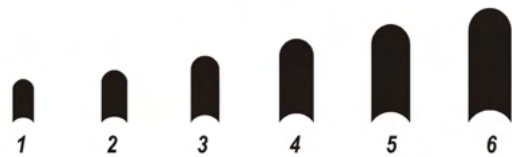

ARTICULO

43

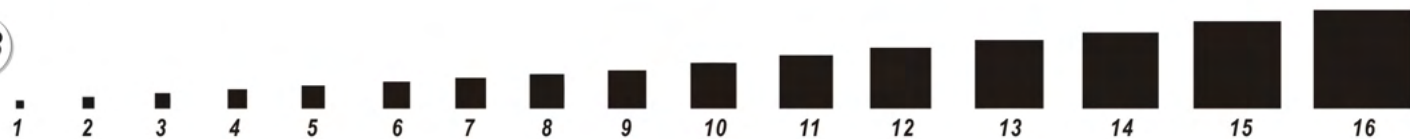

44



45



46

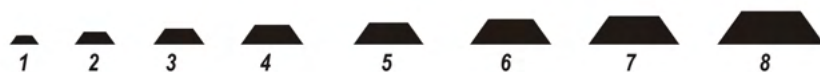

ARTICULO

47



48



49



50



ARTICULO

51-A



51



52



ARTICULO

53



54

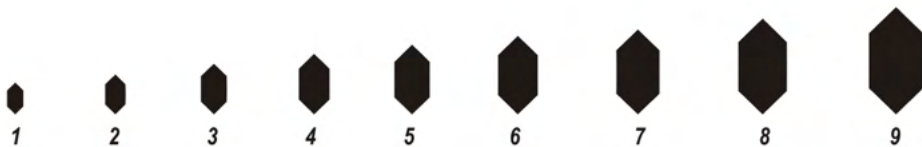

ARTICULO

55



56



57



58



ARTICULO

59

1

2

3

4

5

6

7

8

9

10

11



60

1

2

3

4

5

6



61

1

2

3

4

5

6

7

8

9



62

1

2

3

4

5

6

7

7

8



ARTICULO

63



64



65



66



ARTICULO

67



1



2



3



4



5



6



7



8



9



10



11

68



1



2



3



4



5



6



7



8



9

69



1



2



3



4



5



6



7



8



9



10

70



1



2



3



4



5



6



7



8



9

ARTICULO

71



71



72



72



GILMA®

ARTICULO

73



73



74



75



ARTICULO

76



1



2



3



4



5



1-Z



2-Z



3-Z



4-Z



5-Z

77



1



2



3



4



5



1-Z



2-Z



3-Z



4-Z



5-Z

78



1



2



3



4



5



1-Z



2-Z



3-Z



4-Z



5-Z

79



1



2



3



4



5



1-Z



2-Z



3-Z



4-Z



5-Z

ARTICULO

80



1



2



3



4



5



6

80



1-Z



2-Z



3-Z



4-Z



5-Z



6-Z

ARTICULO

100

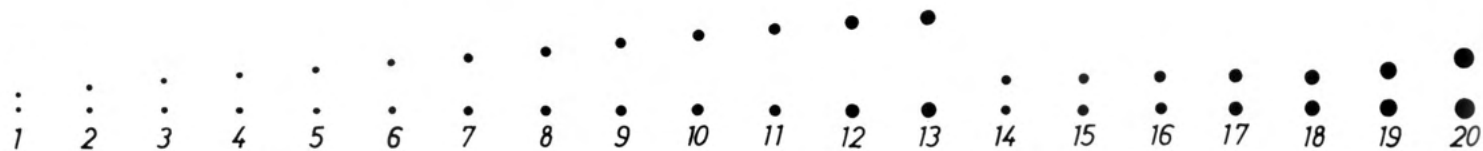

101



104



102



105

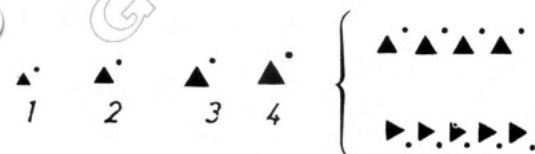

103



106

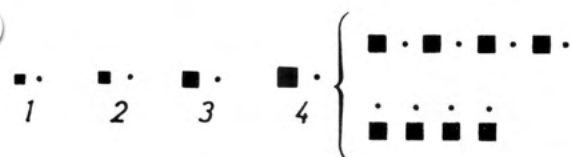

ARTICULO

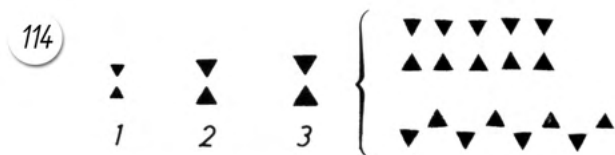
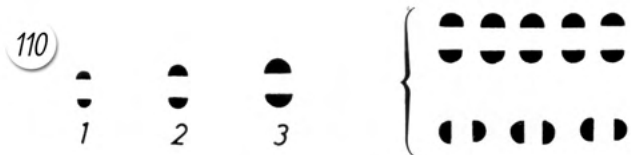
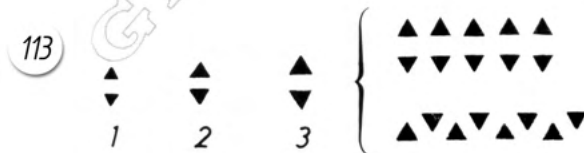
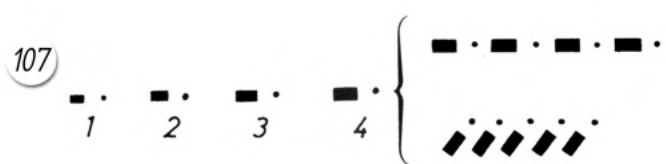

ARTICULO

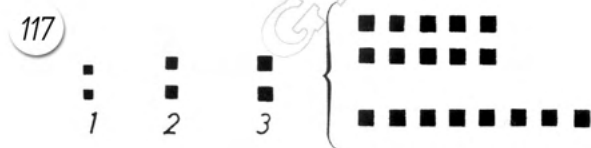

ARTICULO

123

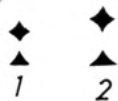

127

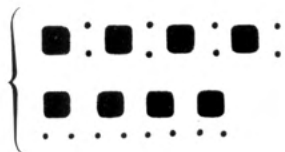

124



128



125



129



126

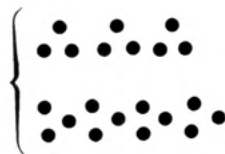

130



ARTICULO

131



132

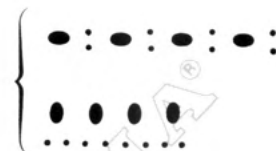
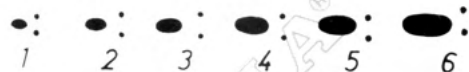

133

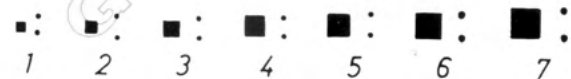

134

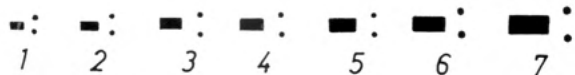

ARTICULO

135



136



139

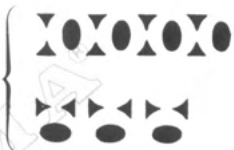

137



140



138

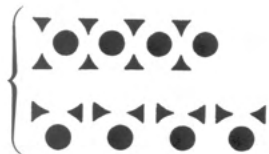

141

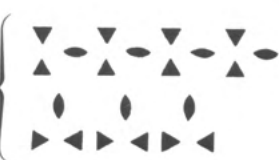

ARTICULO

142

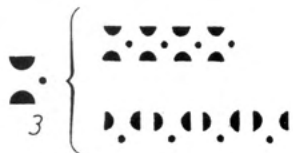

146

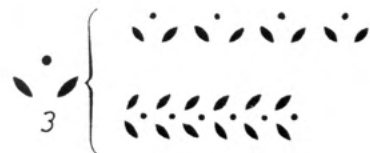

143



147



144



148

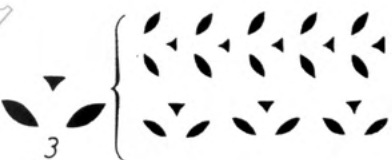

145

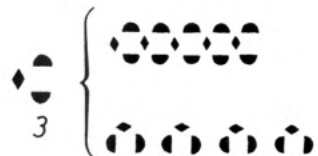

149

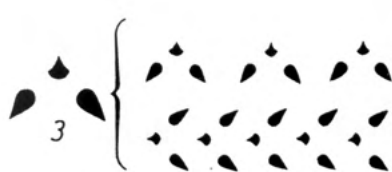

ARTICULO

150

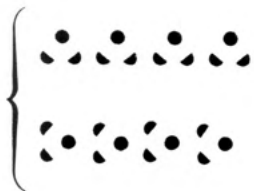

154

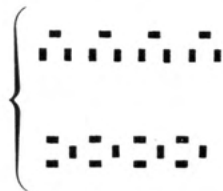

151



155

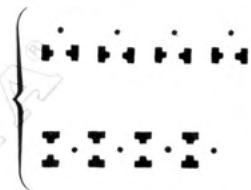
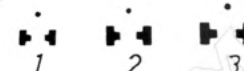

152



156

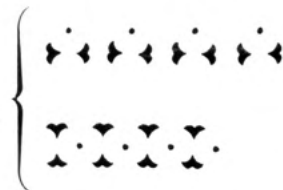

153

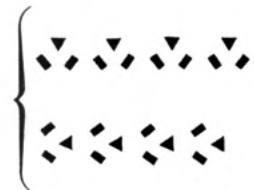

157

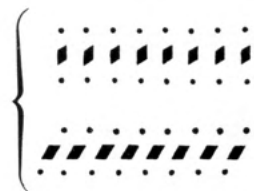

ARTICULO

158



162



159

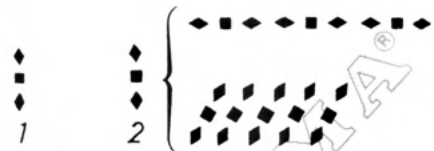

163

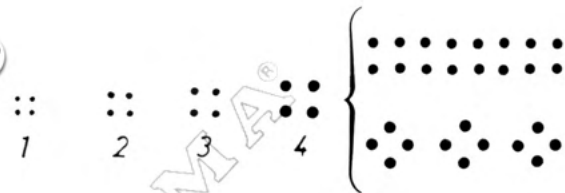

160



164



161

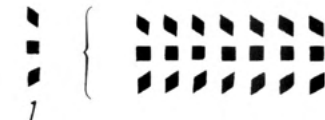

165

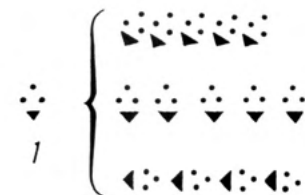

ARTICULO

166



1



2



3

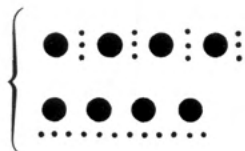

170



1



2



3

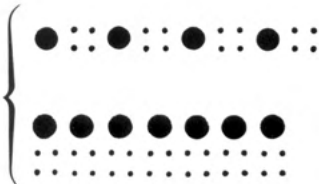

167



1



2



3

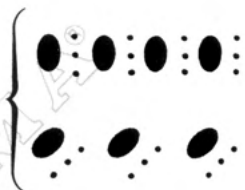

171



1



2



3

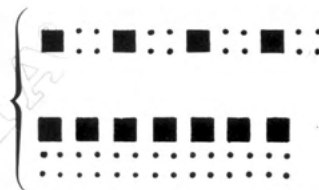

168



1



2



3



172



1



2



3

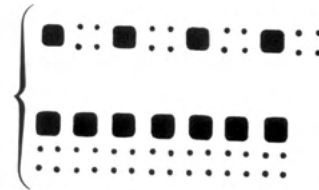

169



1



2



3



173



1



2



3

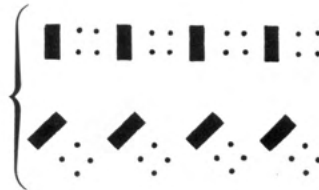

ARTICULO

174



178



175



179



176



180



177

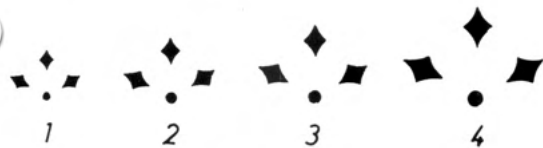

181



ARTICULO

182



186



183

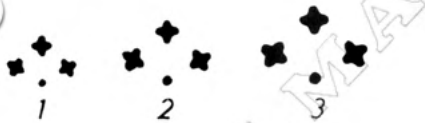

187



184



188



185



189



ARTICULO

190



1



2



3

191



1



2



3

192



1



2



3

193



1



2



3

194



1



2



3

195



1



2



3

196



1



2



3

197



1



2



3

ARTICULO

198



199



200



201

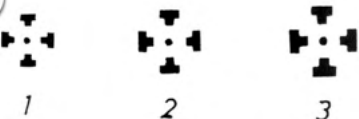

202

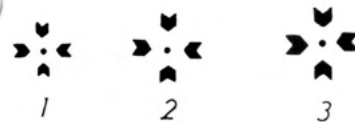

203



204



205



ARTICULO

206



210



207



211

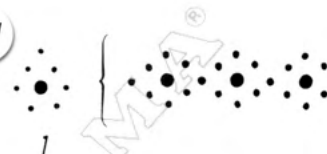

208



212

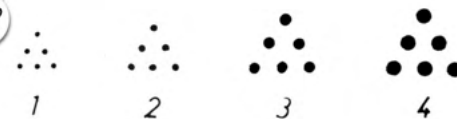

209

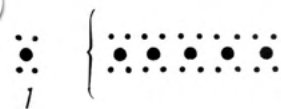

213

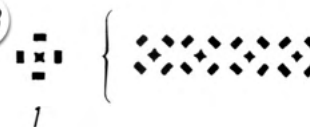

ARTICULO

214



1



2



3



4



5



6



7

215



1

216



1



2



3



4



5

217



1



2



3

218



1



2



3



4



5

219



1



2



3



4



5



4

ARTICULO

220



1



2



3



4



5

221



1



2



3



4



5

222



1



2



3



4



5

223



1



2

224



1



2

225



1

ARTICULO

226



227



228



229



230



231



232



233



234



235



236



237



238



239



240



241



242

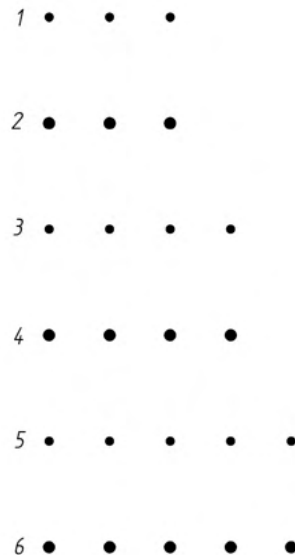

- Especial agujeros correas sandalias.

- Special belt punching sandals.

- Spéciale à perforer les courrotes.

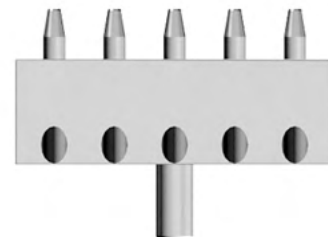

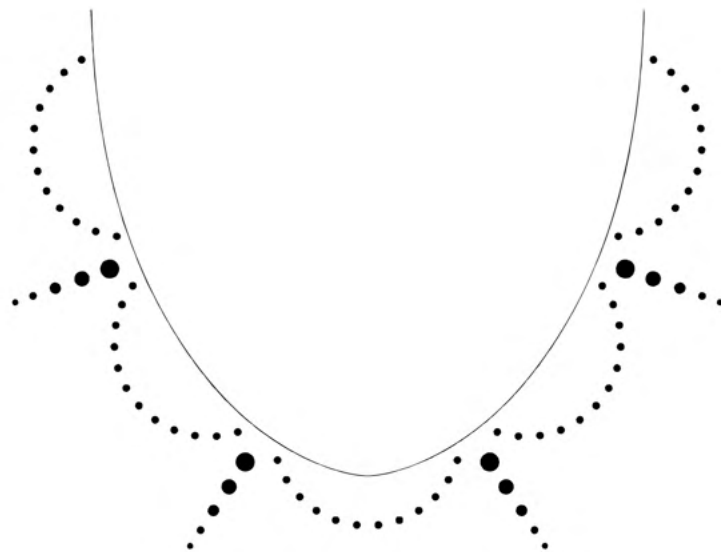
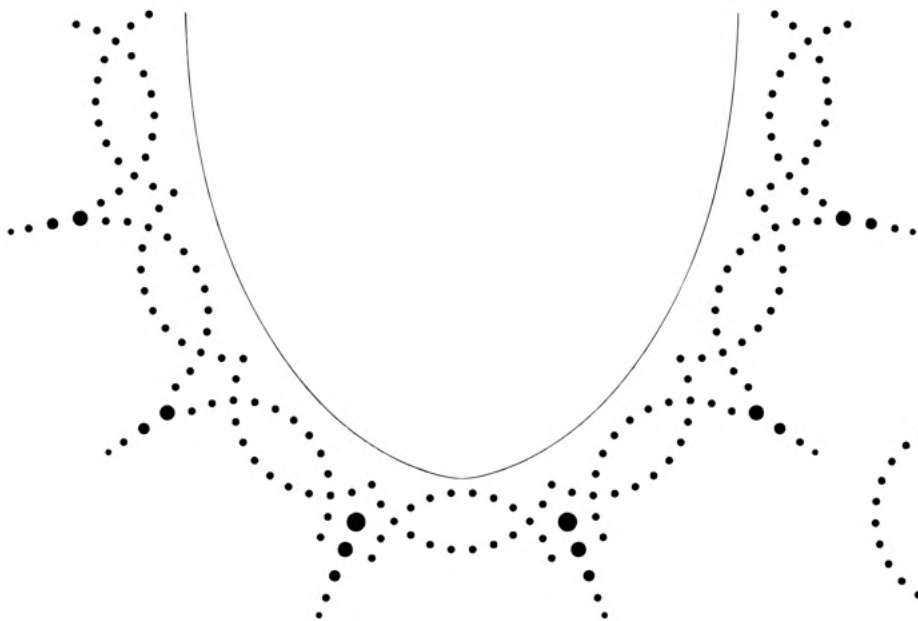

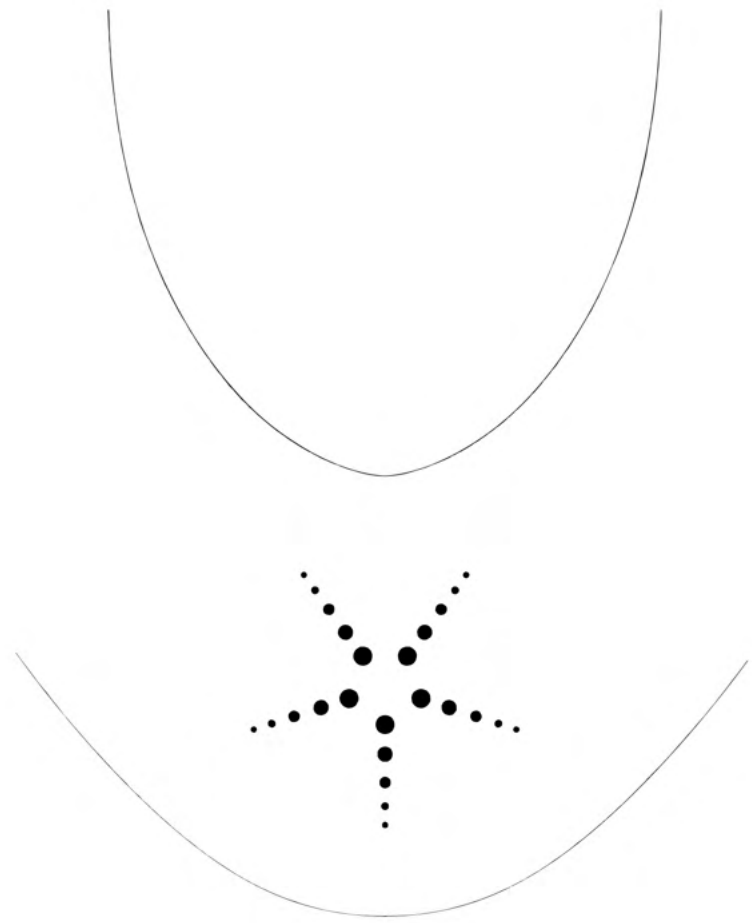
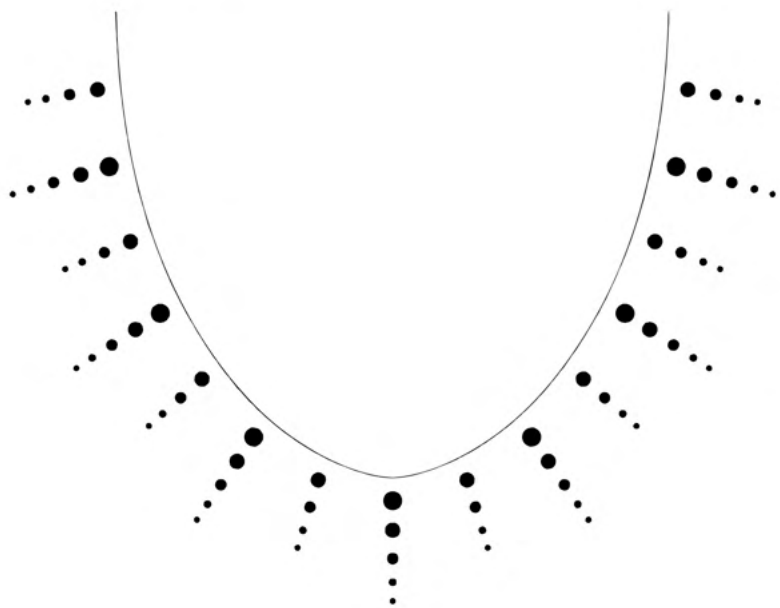

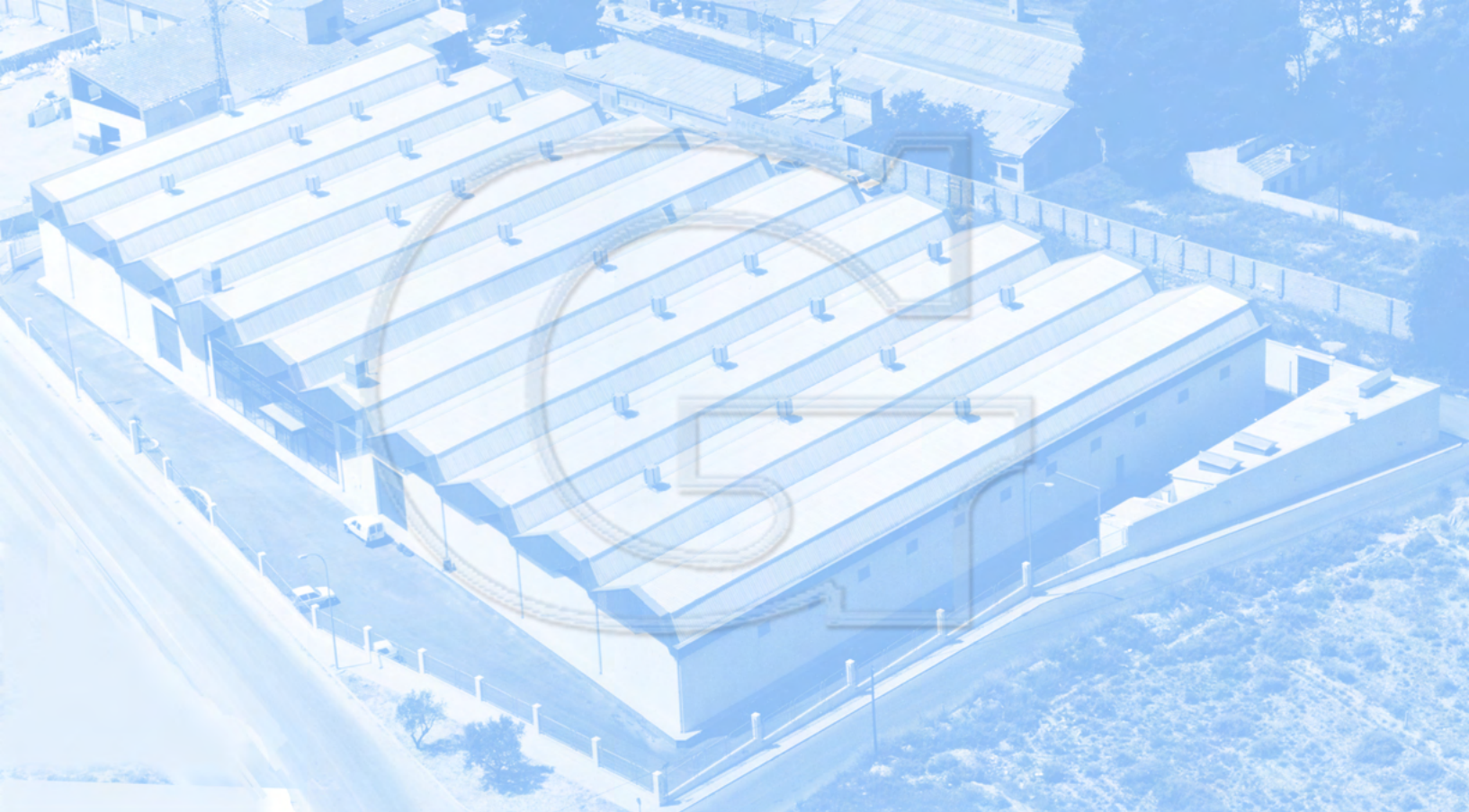

GILMA[®]

TECHNOLOGY S.A

Avda. Costa Vasca, 5 . 03610 PETRER (Alicante) SPAIN . Tel. 96 695 50 50 . Fax: 96 537 34 12
www.gilmatech.com - gilma@gilmatech.com